

AN 141 3D FVZ 14/40

for unrebated 40 mm thick residential doors
with 14 mm recessed frame facings up to 40 kg



Product features

- FVZ = recessed frame facings
- recessed frame facings up to 14,0 mm
- door thickness 40 mm
- completely concealed hinge system
- for timber frames
- for unrebated residential doors
- 3D adjustable (side +/- 1,5 mm, height +/- 2,5 mm, compression +/- 1,0 mm)
- central installation
- material zamak / acetal

Technical details

Attributes	Value
Load capacity	40,0 kg
Overall length	144,0 mm
Width (door part)	30,0 mm
Width (frame part)	30,0 mm
Cutter diameter	14,0 or 16,0 mm
Collar ring diameter	25,0 or 27,0 mm
Opening angle	180°

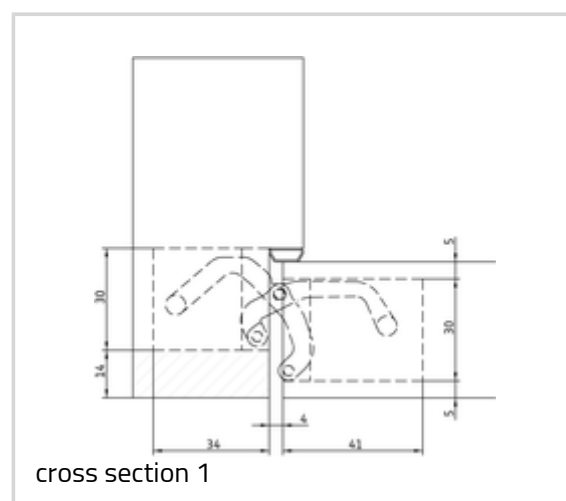
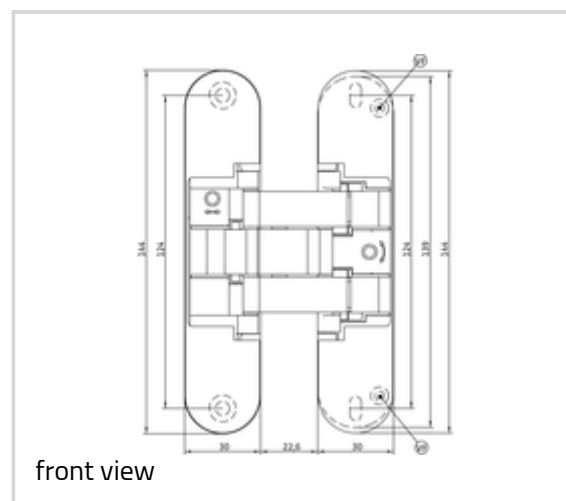

Anselmi - AN 141 3D FVZ 14/40

Note

The load capacity mentioned above refers to the use of 2 hinges per door leaf (900 x 2100 mm).

Suggested screws:

Frame side: Countersunk head screw DIN 7505 A, Diameter 5,0 mm

Door side: Pan head screw DIN 7505 B, Diameter 4,0 mm

If necessary, it is possible to lock the vertical adjustment of the hinge by means of a vertical adjustment fixing screw (VF).

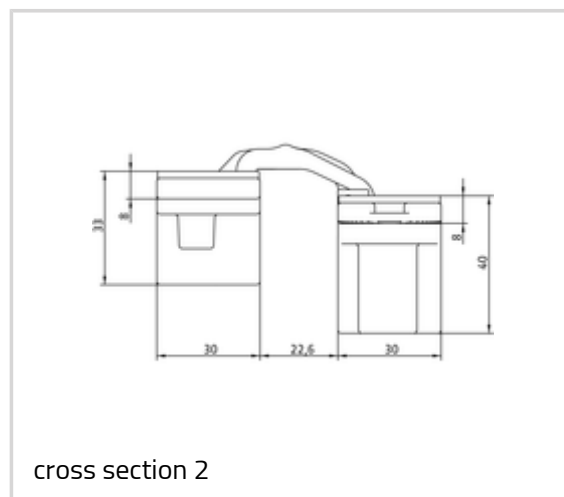

Item

Finish(es)	AN 014-Satin Chrome
OF-NR.	014
VPE	pack of 2
DIN	DIN right and left hand
EAN	8054608703254
Finish(es)	AN 017-Coated Bronze
OF-NR.	017
VPE	pack of 2
DIN	DIN right and left hand
EAN	8054608703087
Finish(es)	AN 018-Black
OF-NR.	018
VPE	pack of 2
DIN	DIN right and left hand
EAN	8054608703094
Finish(es)	AN 035-Antique Bronze
OF-NR.	035
VPE	pack of 2
DIN	DIN right and left hand
EAN	8054608703124
Finish(es)	AN 036-Aluminium Chrome
OF-NR.	036
VPE	pack of 2

Anselmi - AN 141 3D FVZ 14/40

DIN	DIN right and left hand
EAN	8054608703131
Finish(es)	AN 037-Polished Brass
OF-NR.	037
VPE	pack of 2
DIN	DIN right and left hand
EAN	8054608703148
Finish(es)	AN 039-Polished Chrome
OF-NR.	039
VPE	pack of 2
DIN	DIN right and left hand
EAN	8054608703261
Finish(es)	AN 044-Satin Nickel
OF-NR.	044
VPE	pack of 2
DIN	DIN right and left hand
EAN	8054608703100
Finish(es)	AN 049-RAL 9016 Traffic White
OF-NR.	049
VPE	pack of 2
DIN	DIN right and left hand
EAN	8054608703117